

Ethernet PSE power supply module



1.Product features

- Compliant with IEEE802.3bt Type
- 100 ~ 240V wide AC voltage input range.
- Only external AC power supply is needed to achieve the protocol requirements to meet the maximum 90W power supply.
- Overall dimensions: 170mm*71mm*40mm
- High reliability: The design meets the 5 million hour average failure interval.

2.Scope of application

- VCR (NVR, DVR, etc.)
- Small Business Switch
- Compatible with all devices below IEEE802.3bt standard
- Campus network switches and branch switches
- wireless backhaul

3.Description

- WC-PSE90B01 is a single port input 220AC IEEE802.3at power supply equipment (PSE) for flexible use through Ethernet (POE) applications.
- The power supply device (PD) with valid signature is automatically detected, and the power supply demand is determined according to the classification, and the power supply is applied. Supports two event classification for type 2 PD.
- The WC-PSE12-52V is an independent module that requires only a few external components to provide a large amount of control and feedback for each power supply unit (PD) connected to the PSE.

4. Mechanical dimensions



Company (mm)

All the above dimensional errors: (± 0.3)

5. pin definition

Product Name	PoE Power supply terminal equipment.	
Supporting standards	IEEE802.3af, IEEE802.3at, IEEE802.3bt.	
Port	LAN port: one 100 / 1000M adaptive RJ45 port PSE port: one 100 / 1000M adaptive RJ45 port	
basic function	Compatible with IEEE 802.3af/at/bt standard The maximum transmission distance is 1000M, plug and play without management.	
LED	PoE-OK	Red LED indicator, indicating whether the power supply voltage is connected.
	PoE-Out	The green LED indicates the protocol handshake of Poe receiver.
Input voltage	AC 100V~240V 47Hz~63Hz	
output power	IEEE802.3af, IEEE802.3at, IEEE802.3bt /MAX:90W	
Use environment	Working temperature: - 10°C~50°C Working humidity: 10% - 90% non condensing condensing	storage temperature: - 40°C~70°C storage humidity: 5% - 90% non
PoE type	End bridging method / middle bridging method	
PoE port characteristics	Type 1 802.3af/Type 2 802.3at/Type 3 802.3bt/Type 4 802.3bt	
PoE wire core	Also supports 1/2+, 3/6-pair (4/5+, 7/8-pair)	
size	170mm*70mm*40mm (No terminal line added)	



5. Electrical characteristics

5.1 Absolute maximum rating parameter

No	parameter	Symbol	MIN	MAX	Units
1	DC Voltage	VCC	44	57	V
2	DC Voltage Surge 1ms	VSURGE	-0.6	20	V
3	ambient temperature	TS	-40	110	°C

*Exceeding the above rating may cause permanent damage to the product. Functional operations under these conditions are not recommended.

5.2 Recommended working conditions

No	parameter	Symbol	MIN	TYP	MAX	Units
1	input voltage	VIN	44	48	57	V
2	Low Voltage Lock	VLOCK	25	-	-	V
3	working temperature	TOP	-40	25	80	°C

*Applicable only to WC-PSE90B01 maximum operating temperature.

5.3 Characteristic

No	PARAMETER	TEST CONDITIONS	MIN	TYP	MAX	UNIT
DETECTION						
1	I _{DISC} Detect Current	Checkpoints 1 and 3, V _{VPWR} - V _{DRAINn} = 0V	145	160	190	μA
2		Checkpoints 2 and 4, V _{VPWR} - V _{DRAINn} = 0V	235	270	300	μA
3		High Current detection point, V _{VPWR} - V _{DRAINn} = 0 V	490	540	585	μA
4	Δ I _{IDET} currents 2nd - 1st detection	At V _{VPWR} - V _{DRAINn} = 0 V	98	110	118	μA
5	V _{detect} Open circuit detection voltage	V _{VPWR} - V _{DRAINn}	23.5	26	29	V
6	R _{REJ-LOW} Rejected resistance low range		0.85		15	KΩ
7	R _{REJ-HI} Rejected resistance high range		33		50	KΩ
8	R _{ACCEPT} Accepted resistance range		19	25	26.5	KΩ
9	R _{SHORT} Shorted port threshold				350	KΩ
10	R _{OPEN} Open port threshold		55			KΩ

(1) The technical parameters are for reference only and do NOT constitute part of the guarantee of the company's product specifications

(2) Output ripple and noise can be reduced by an external filter, see the application instructions.

5.4 Characteristic (continued)

No	PARAMETER	TEST CONDITIONS	MIN	TYP	MAX	UNIT
CLASSIFICATION						
1	V _{CLASS} Classification voltage	$V_{VPWR} - V_{DRAINn}, V_{SENn} \geq 0$ mV, $I_{port} \geq 180 \mu A,$	15.5	18.5	20.5	V
2	C _{CLASS-Lim} Classification current limit	$V_{VPWR} - V_{DRAINn} = 0 V$	65	80	90	mA
3	I _{CLASS_TH} Classification threshold current	Class 0-1	5	-	8	mA
4		Class 1-2	13	-	16	mA
5		Class 2-3	21	-	25	mA
6		Class 3-4	31	-	35	mA
7		Class 4-overcurrent	45	-	51	mA
8		Maximum Output Power	Class 4-overcurrent	-	-	90
9	Current Limit	Class 4-overcurrent	-	1.8	1.9	A
10	Current Limit Cut-Off Time		-	60	70	ms
11	Maintain Power Signature		5	-	10	mA

6. Port Output

The Port output can be connected directly to the centre-tap of an IEEE802.3bt compliant data transformer or to the spare pair connection for 100/1000BASE-T applications, as shown in Figure For 1000BASE-T (Gigabit) Ethernet applications all four cable pairs require magnetics, this is explained in more detail in application note .

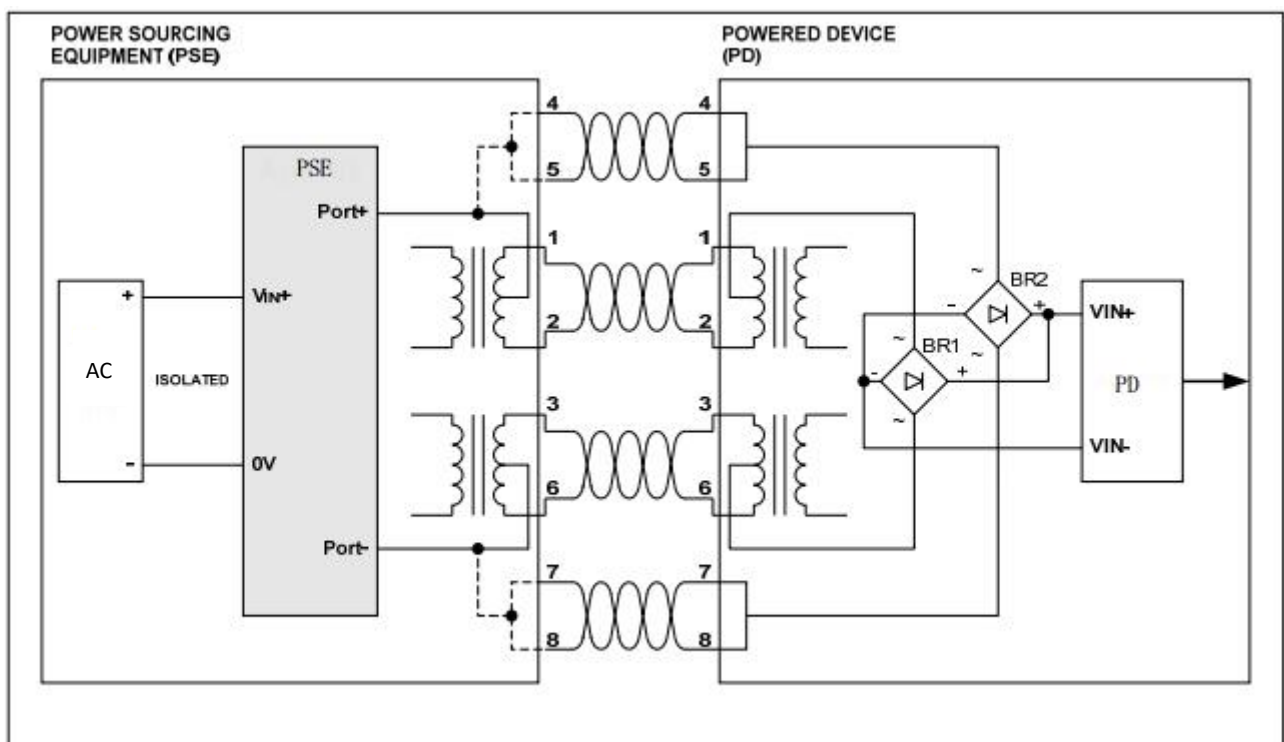

7. PSE Product naming rules

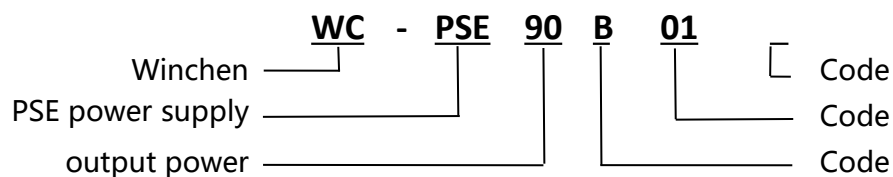

8. Typical applications

This module is used in PSE network cable to convert electric energy to DC-DC to the required voltage of equipment without affecting data signal transmission. It conforms to IEEE 802.3bt standard and is used by all equipment terminals.

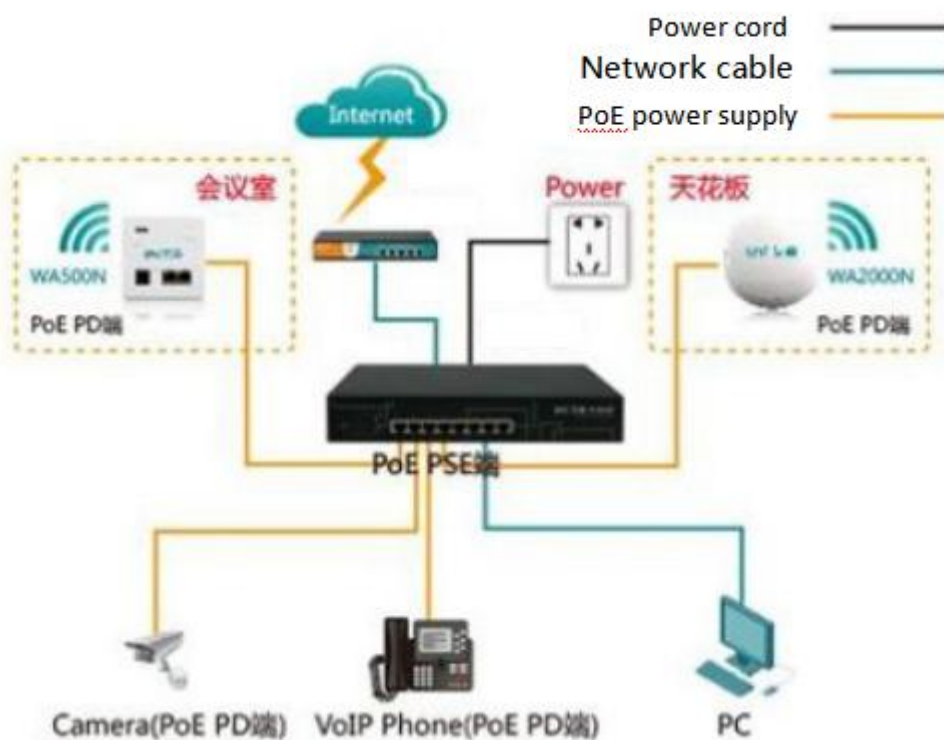

9. Signature and Classification

WC-PSE90B01 will automatically perform signature and classification. The sequence diagram of power equipment (PD) is shown below.

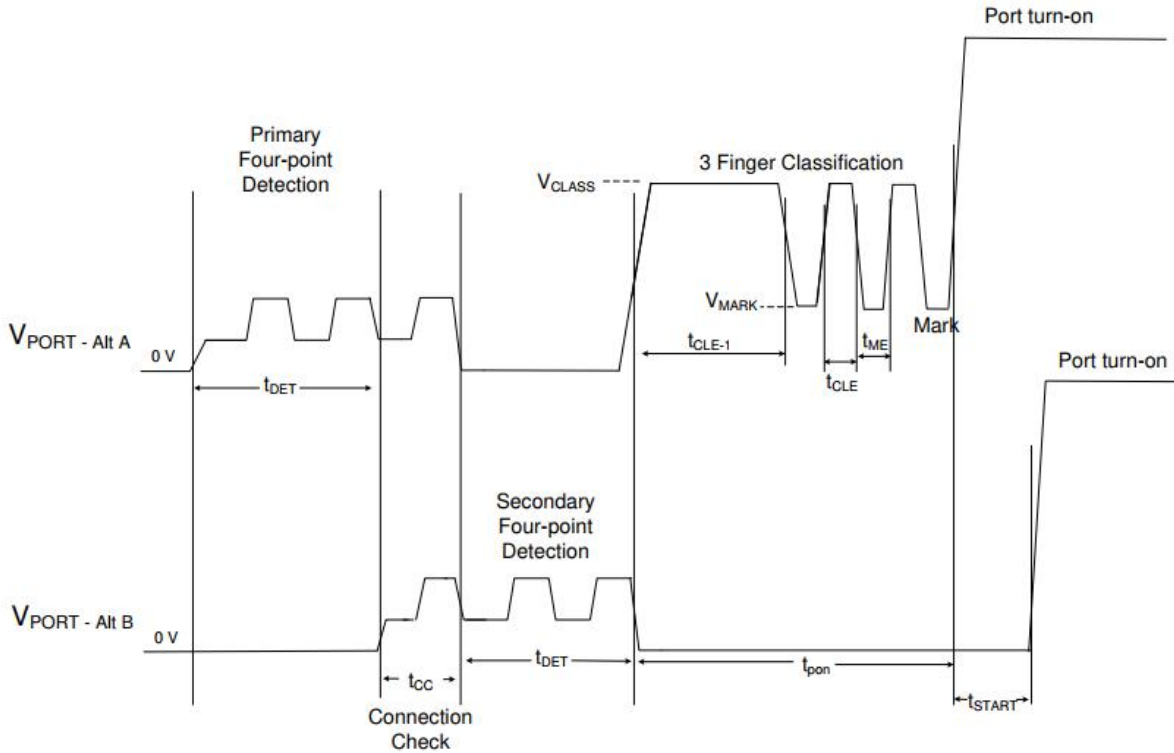

4-Pair single feature detection, 3 event classification and opening

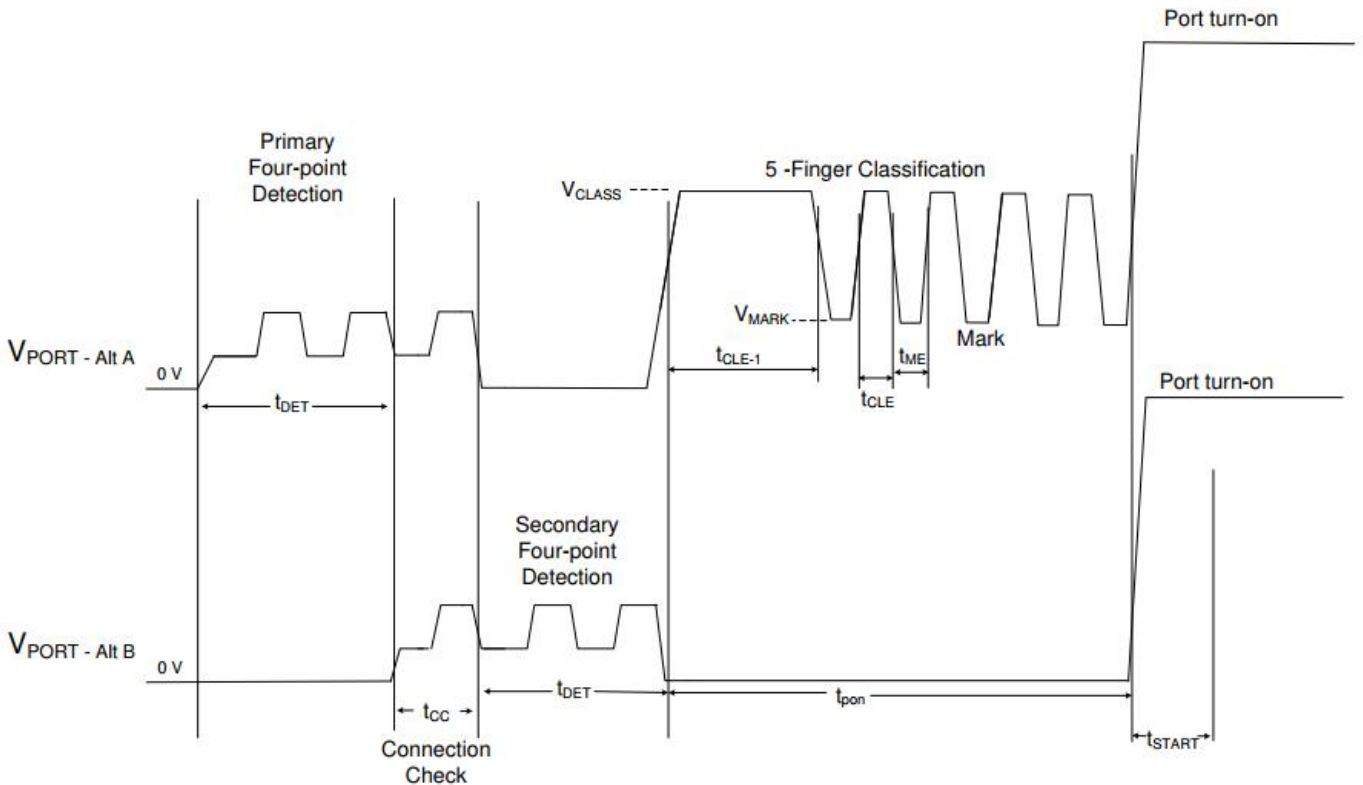

4-Pair single feature detection, 5 event grading and opening

Sequence diagram (Continued)

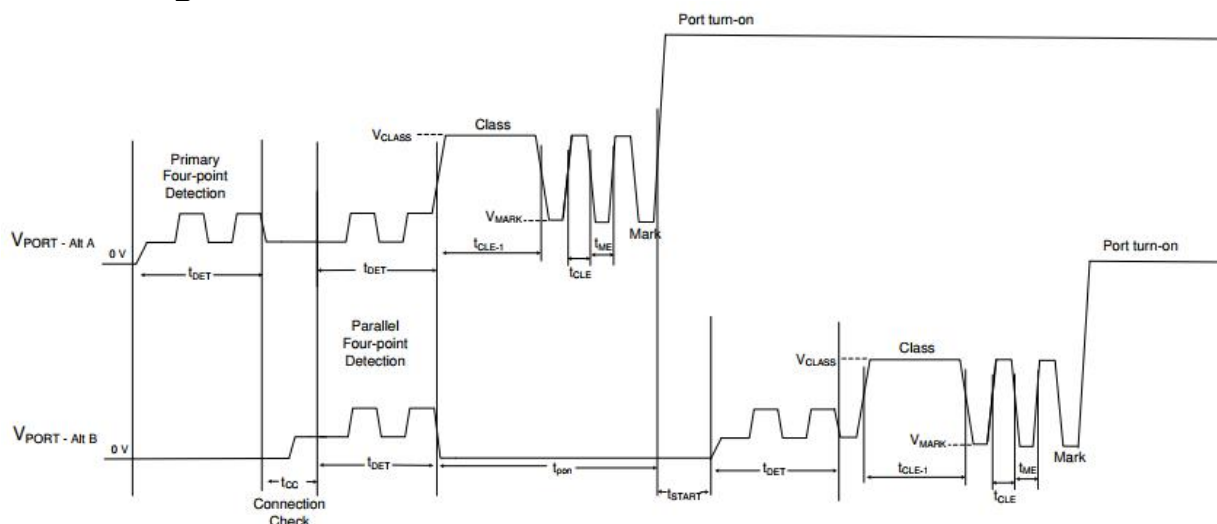

4-Pair double feature detection, 3 event classification and opening

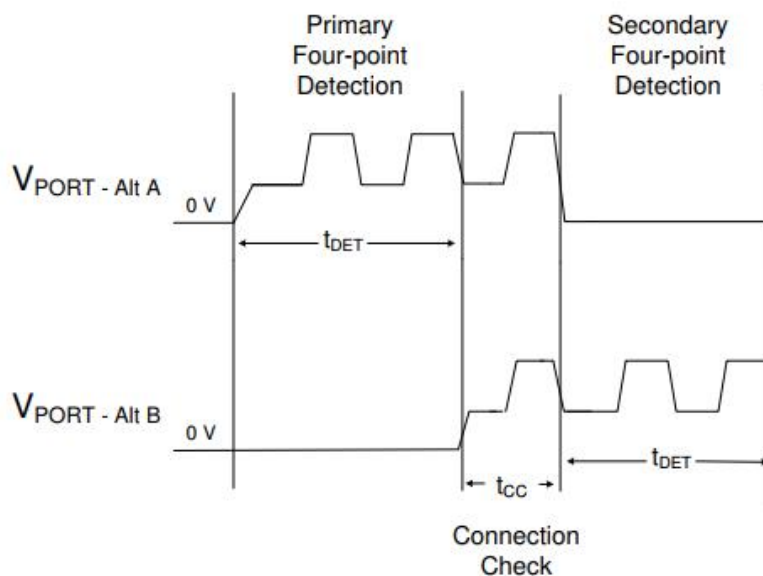

4-wire port detection and connection check waveform under single characteristic load

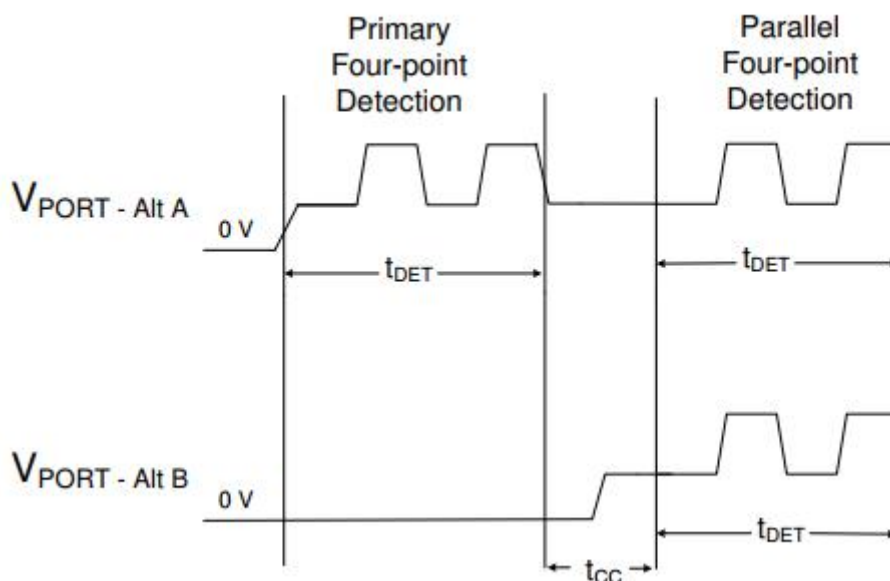

4-wire port detection and connection check waveform under dual characteristic loa

9.1 Power Classification

Under IEEE 802.3bt standard, power processing is divided into two basic categories "type 3" and "type 4"
 In short, the power requirement of type 3 is as high as 60W, and that of type 3 is as high as 90W.

Define criteria	Cable requirements	Grading parameters	Power Supply Characteristics
IEEE802.3af (POE)	CAT5 cable	Maximum power required for Class0 devices is 0~12.95W	The DC voltage ranges from 37 to 57V, with a typical value of 48V.
		The maximum power required for Class1 devices is 0~3.84W	Typical operating current is 10~350mA; typical output power: 15.4W;
		The maximum power required for Class2 devices is 3.85W~6.49W	The overload detection current is 350~500mA.
		The maximum power required for Class3 devices is 6.5W~12.95W	Provide 4 Class Power Requests for PD Devices ranging from 3.84 to 12.95W
IEEE802.3at (POE Plus)	CAT5 cable or CAT6 cable	Maximum power required for Class4 devices is 13W~25.5W	The DC voltage ranges from 44 to 57V, with a typical value of 48V. Typical operating current is 10~600mA; typical output power: 30W; Class4 rating supported by electrical equipment
IEEE802.3bt	CAT6 cable	Maximum power required for type 3 devices is 50W~60W	The DC voltage ranges from 48 to 57V, with a typical value of 48V. Typical operating current is 600~1250mA; typical output power: 60W;
		Maximum power required for type 4 devices is 60W~90W	The DC voltage ranges from 48 to 57V, with a typical value of 48V. Typical operating current is 1250~1800mA; typical output power: 90W;

Poe corresponding power level diagram

9.2 Signature Detection

To ensure that the does not apply power to a non PoE enabled device the Port output first checks for a valid PoE signature. The PD should present a nominal 25kΩ(19kΩ to 26.5kΩ) Signature resistance; if the does not see a valid signature then it will disconnect, wait approximately 2 seconds then try again, see below.

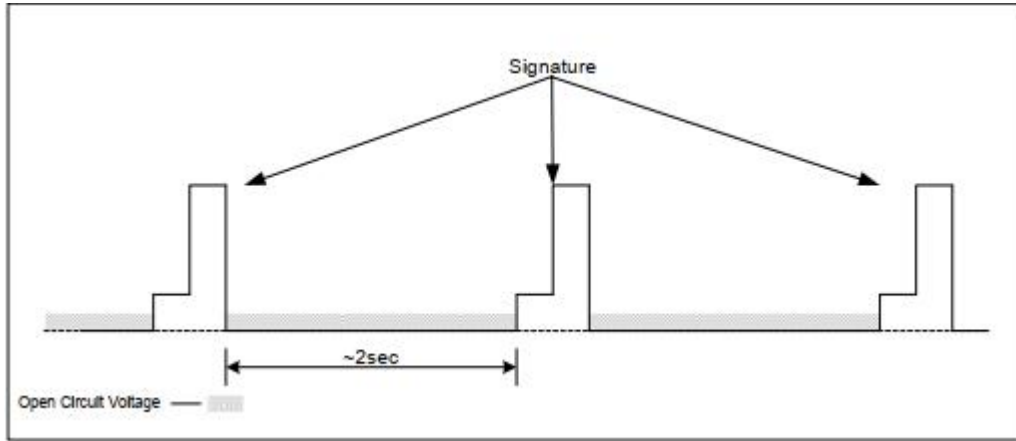

output characteristic

10. 1 Maintain Power Signature

After successful completion of a valid signature (and classification), the module applies the main power supply to the port output. Once the main power supply is applied, the module continuously monitors the PD, and if the extracted current is below the detection threshold, the power is eliminated. If the output current of the module port is $\geq 10\text{mA}$, the output will remain on. If the output current of the port is $\leq 5\text{mA}$, the output will be turned off.

10.2 Output Current Limits

The module has over-current limit protection. If the output of the port continues to exceed the current limit, the output will be belching protection, and it will recover automatically after the output demand current is normal.

10.3 Input Protection

The WC-PSE90B01 has built-in Tranzorb diode across its input, to protect the module from transients from the power supply.

10.4 Short-Circuit Protection

In addition to over-current protection, WC-PSE90B01 also has built-in input under voltage, over temperature, soft start and output short-circuit protection.

10. Typical Characteristics

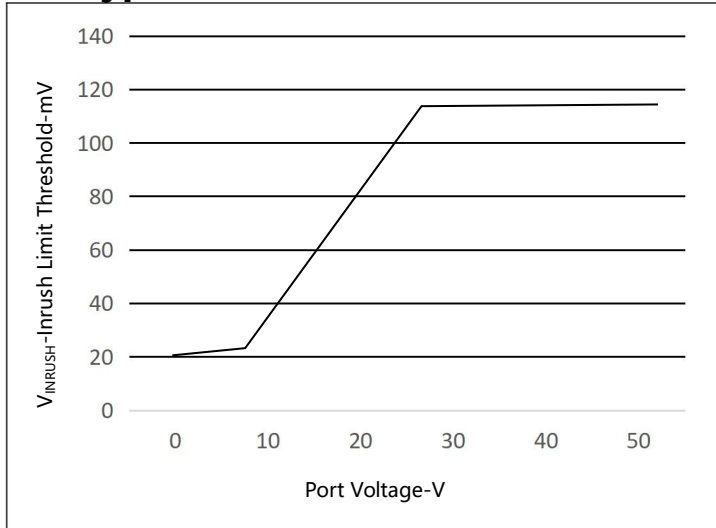

Inrush Current Limit Threshold vs Port Voltage

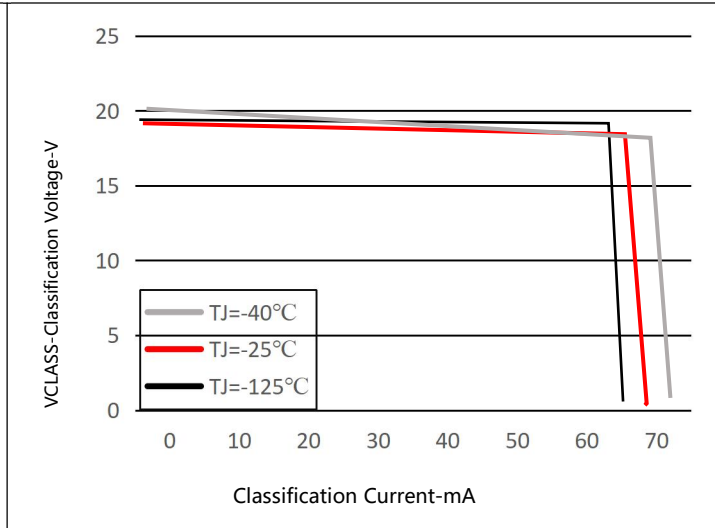

Classification Voltage vs Port Classification Current

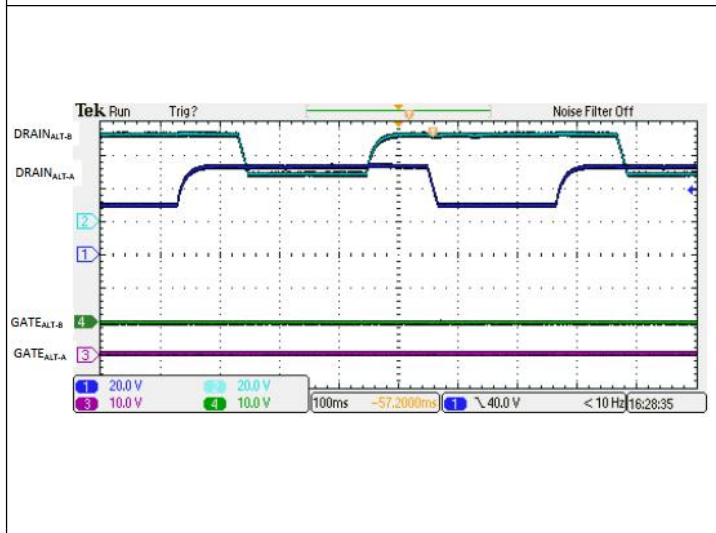

4 - line pair open - circuit detection features

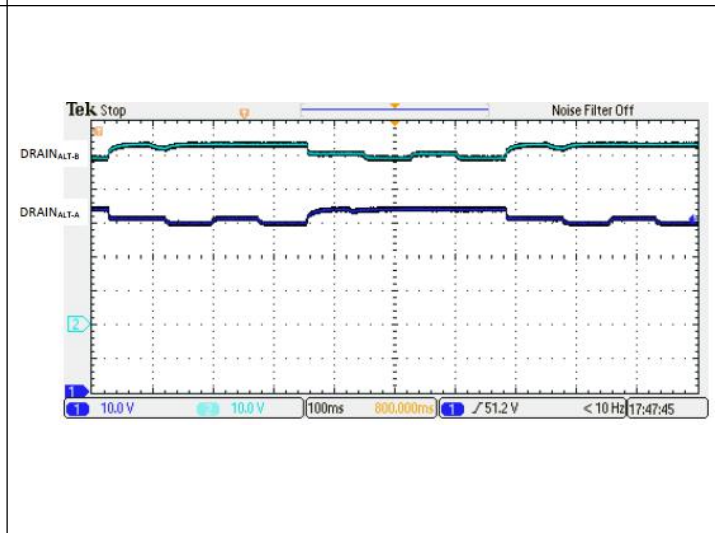

Detection characteristics of 4-Pair low resistance (11K Ω)

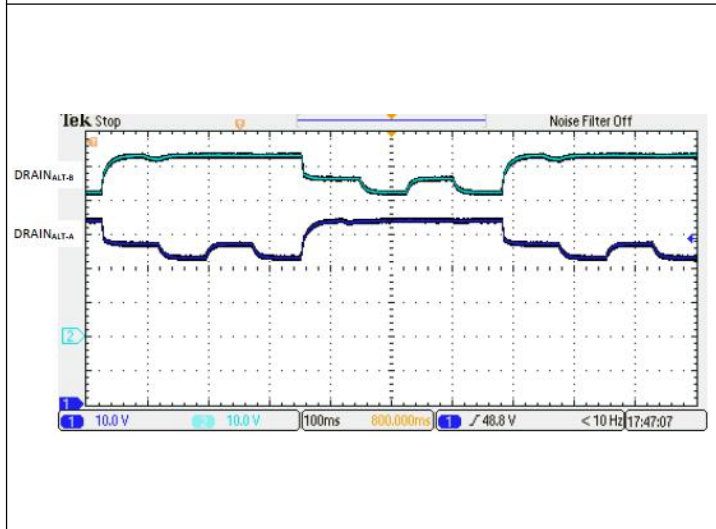

Detection characteristics of 4-Pair high resistance (36K Ω)

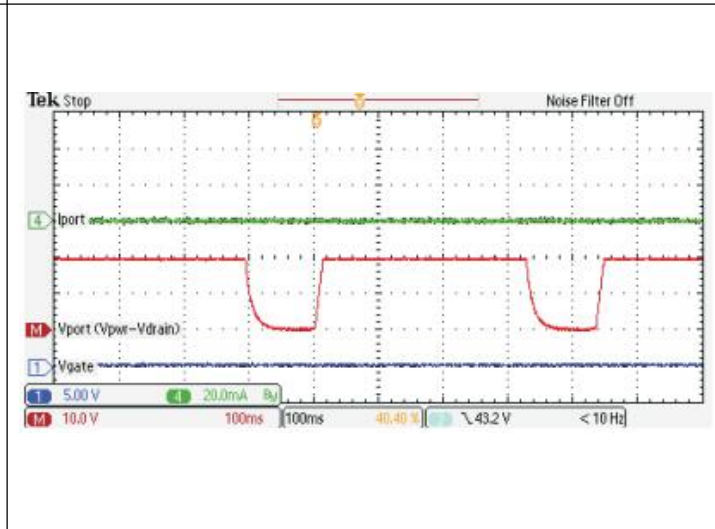

Detection with Invalid PD (open circuit)

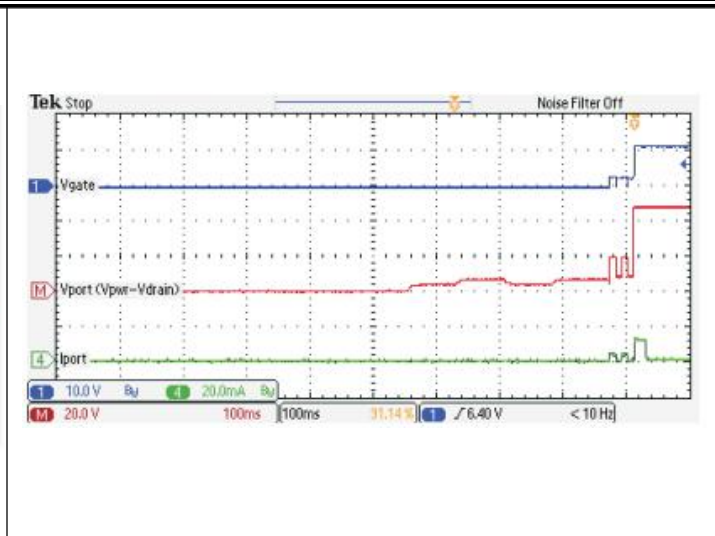
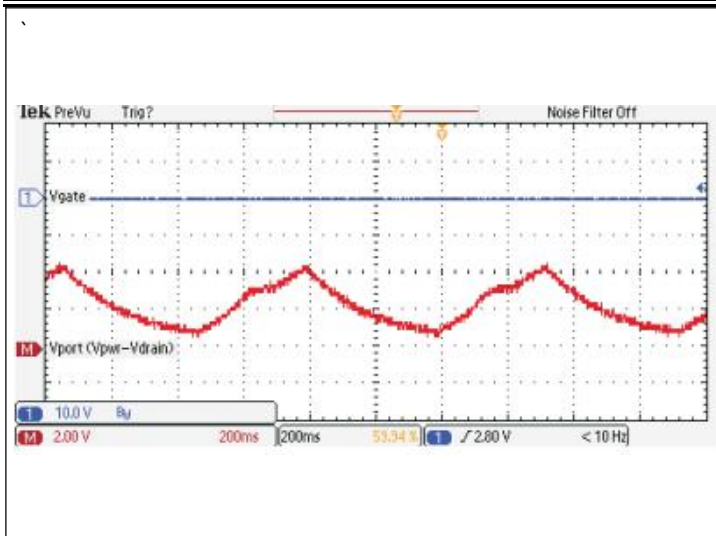

Detection with Invalid PD (25 kΩ and 10 μF)

Event Class and Startup with Valid PD

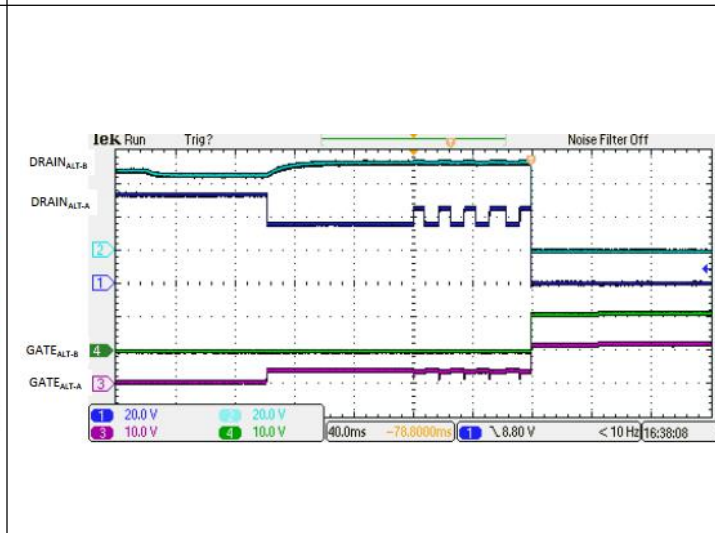
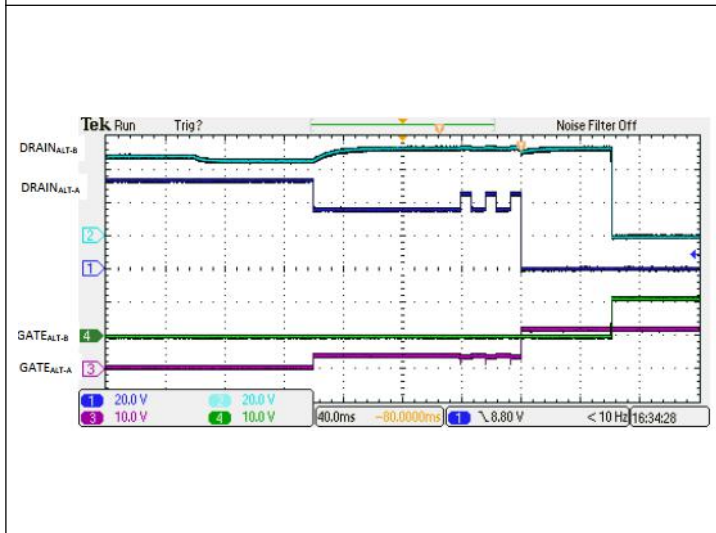

4-Pair single feature 3-finger grading and opening

4-Pair single feature 5-Finger grading and opening

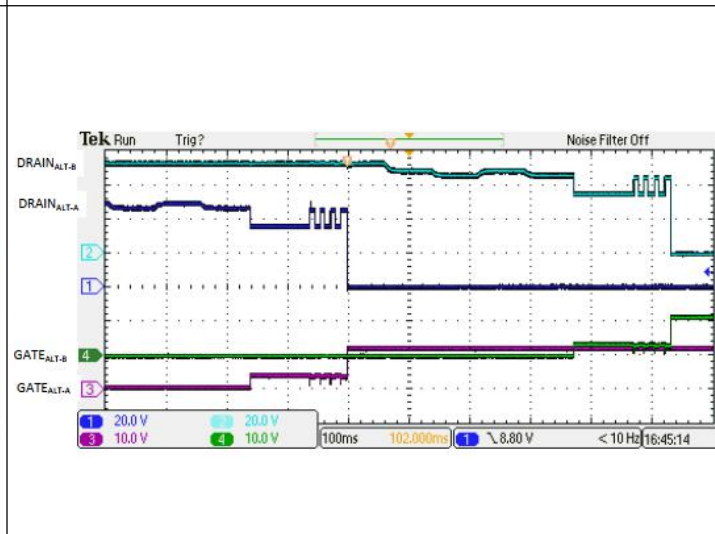
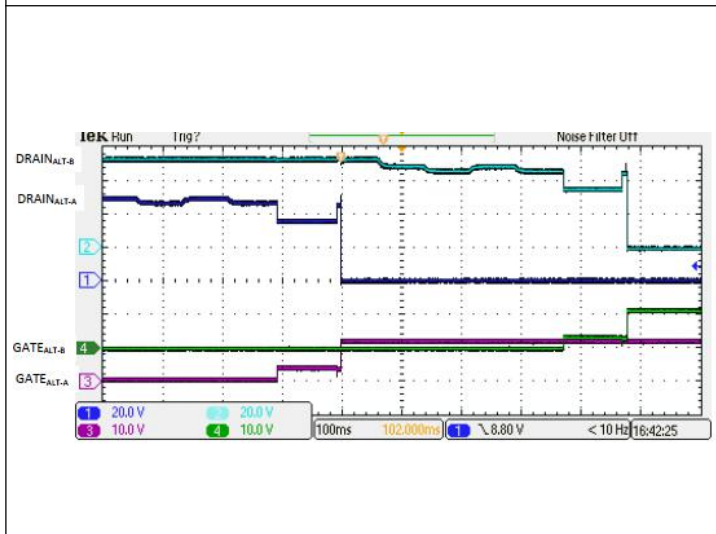

4-Pair dual feature 1 finger grading and opening

4-Pair dual feature 4-finger grading and opening